

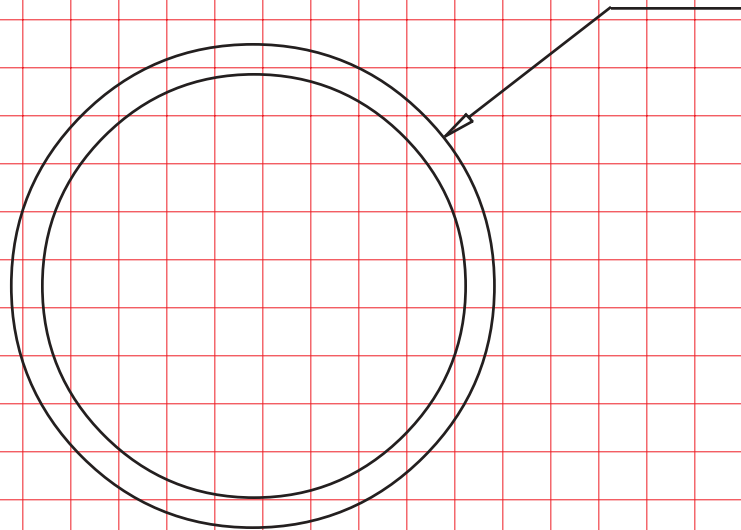

REEVES
EXTRUDED
PRODUCTS, INC.
CUSTOM EXTRUSIONS

661-854-5970 • FAX 661-854-4115
(800) 868-5970

TUBING



Diameters from 1/4" O.D. to 8" O.D.

Wall thickness from .060 to .156

Part Number T-601-REP



REEVES
EXTRUDED
PRODUCTS, INC.
CUSTOM EXTRUSIONS

661-854-5970 • FAX 661-854-4115
(800) 868-5970

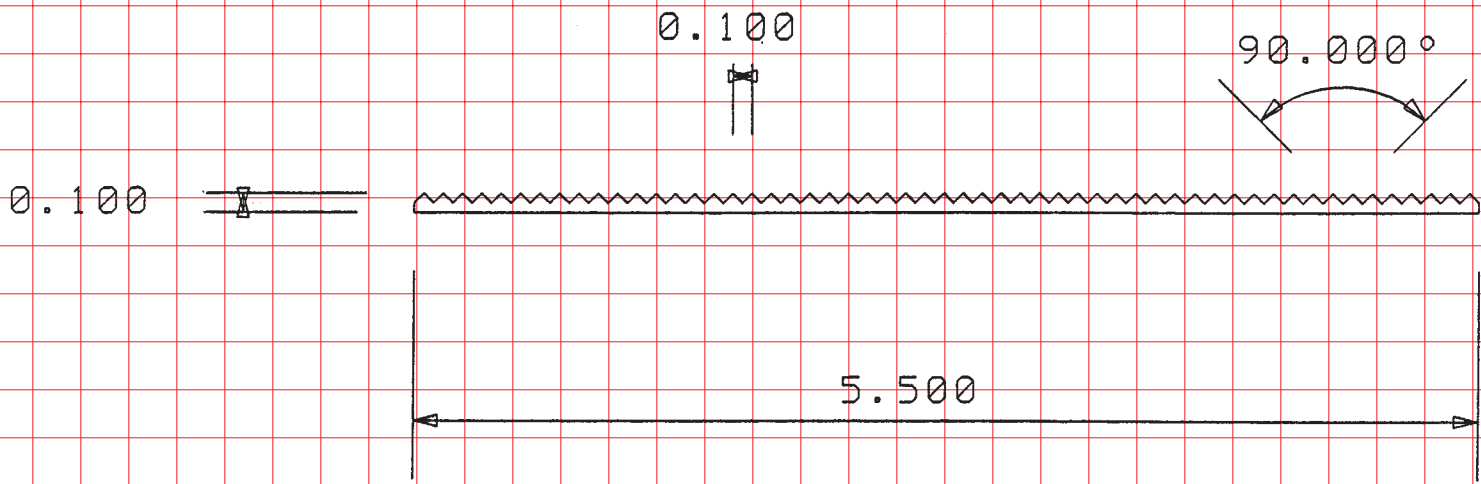

Part Number G-201-REP



REEVES
EXTRUDED
PRODUCTS, INC.
CUSTOM EXTRUSIONS

661-854-5970 • FAX 661-854-4115
(800) 868-5970

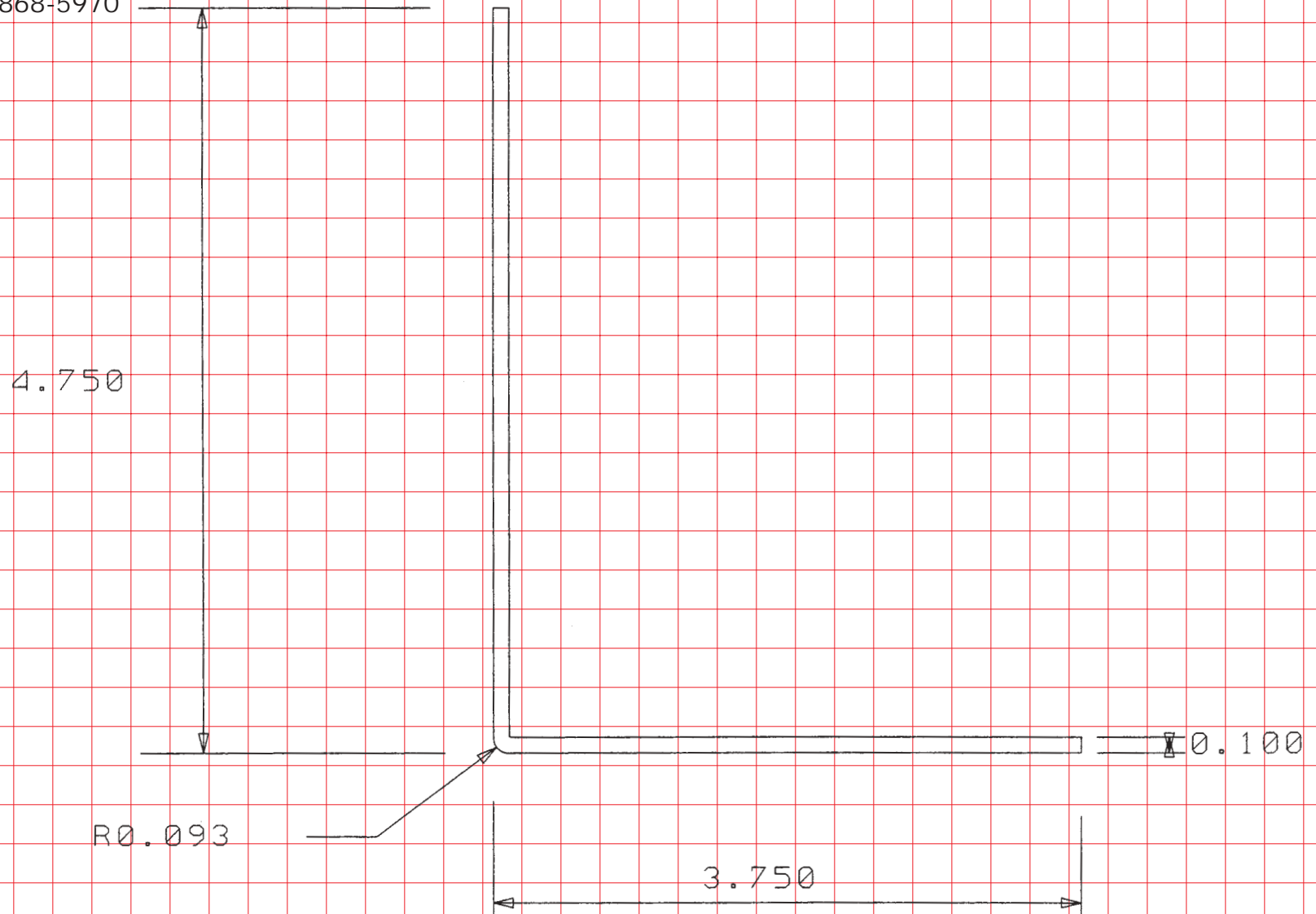

Part Number L-701-REP



REEVES
EXTRUDED
PRODUCTS, INC.
CUSTOM EXTRUSIONS

661-854-5970 • FAX 661-854-4115
(800) 868-5970

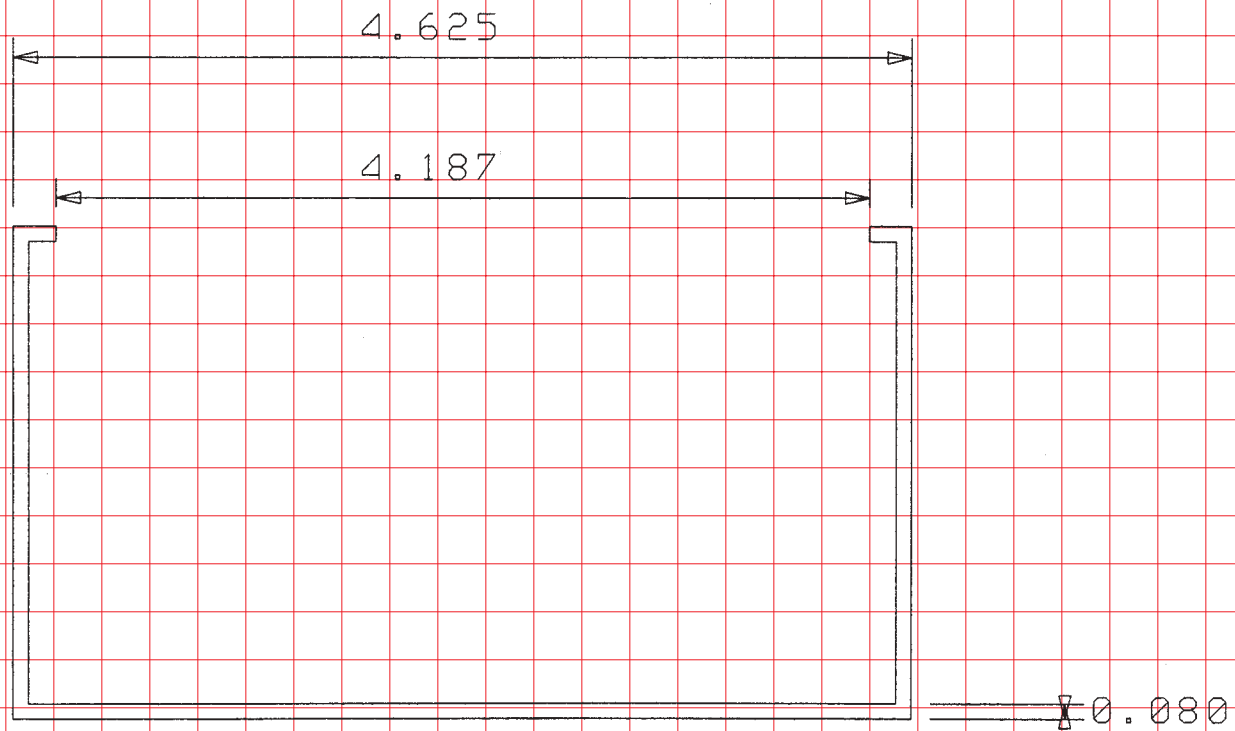

Part Number L-705-REP



REEVES
EXTRUDED
PRODUCTS, INC.
CUSTOM EXTRUSIONS

661-854-5970 • FAX 661-854-4115
(800) 868-5970

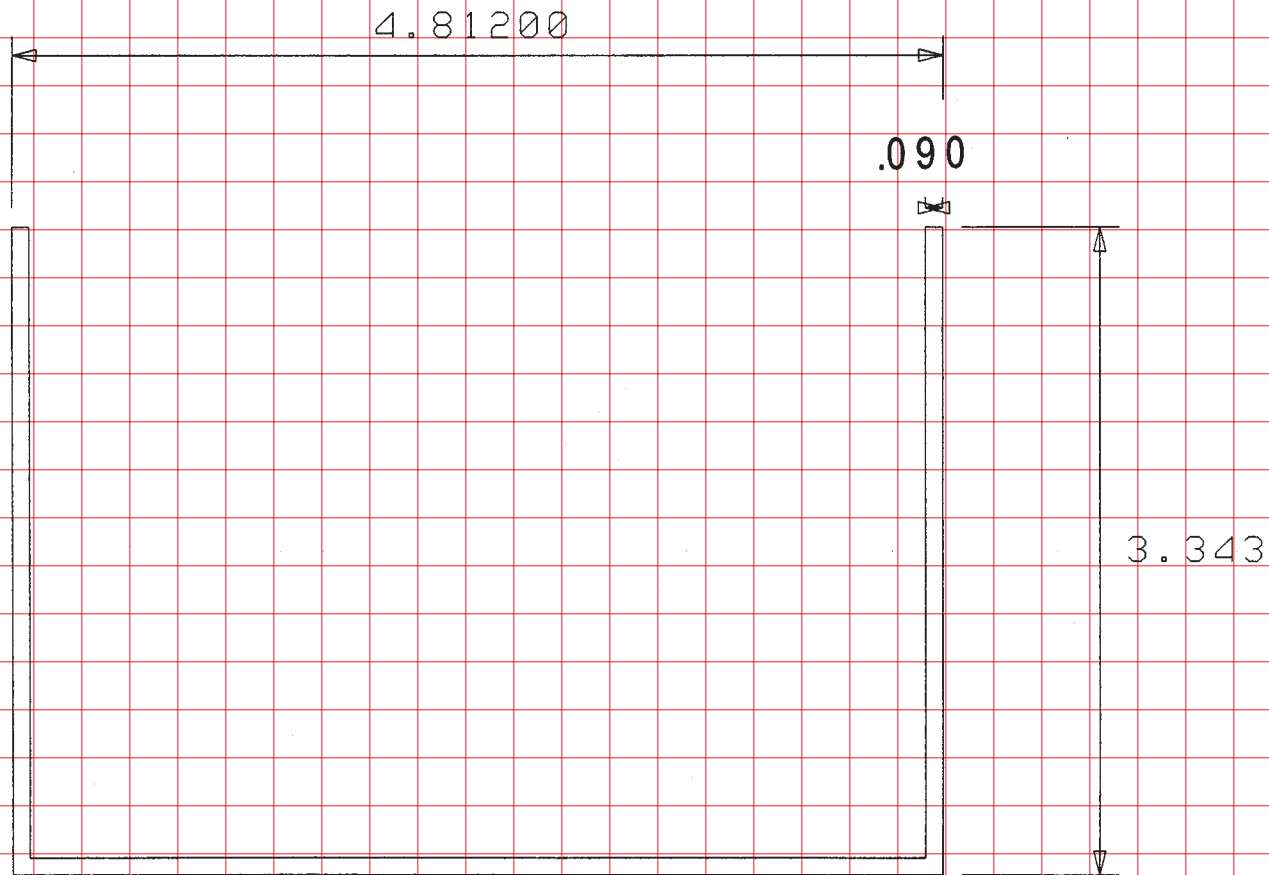

Part Number L-703-REP



REEVES
EXTRUDED
PRODUCTS, INC.
CUSTOM EXTRUSIONS

661-854-5970 • FAX 661-854-4115
(800) 868-5970

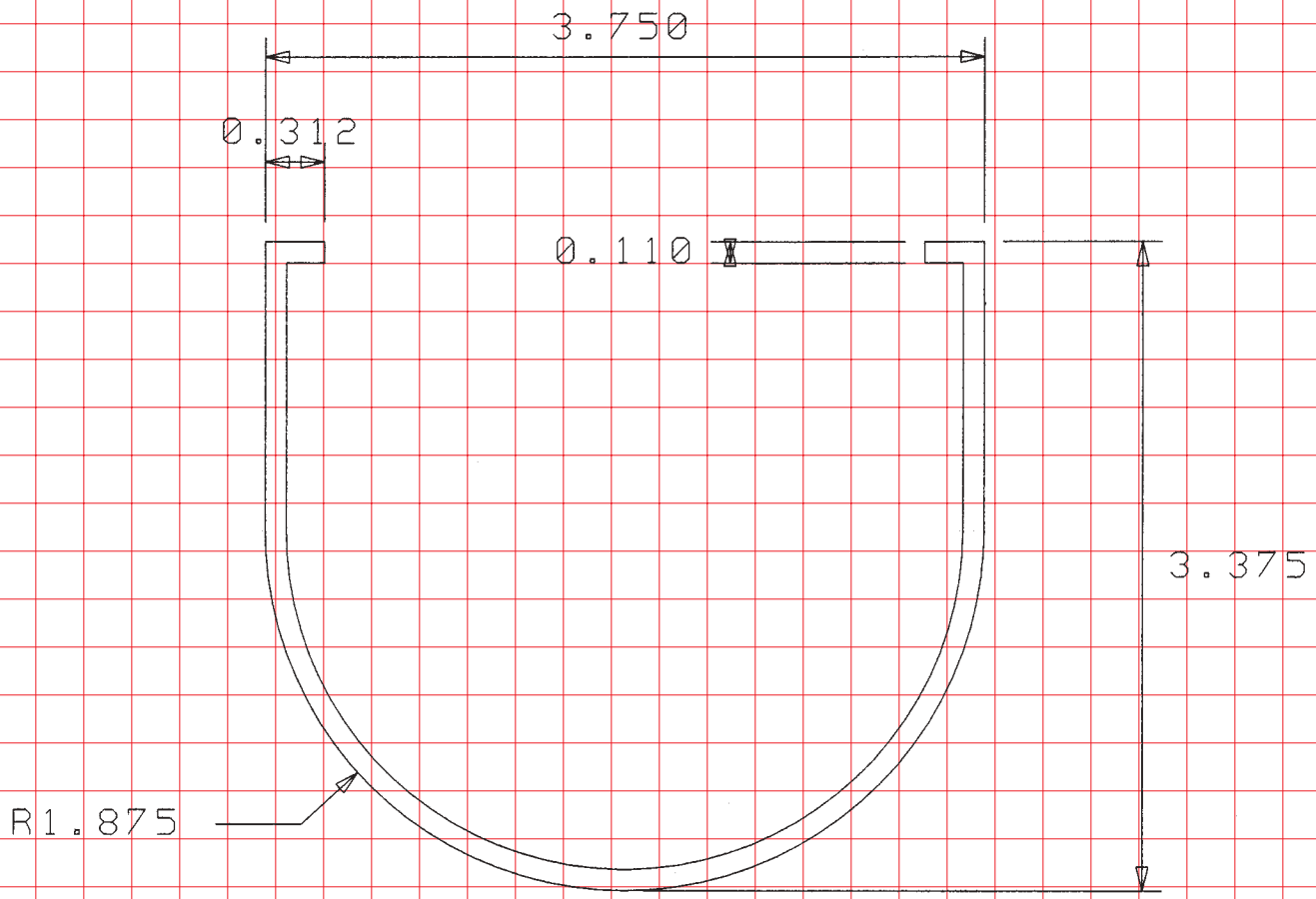

Part Number L-707-REP



REEVES
EXTRUDED
PRODUCTS, INC.
CUSTOM EXTRUSIONS

661-854-5970 • FAX 661-854-4115
(800) 868-5970

* Available with white
injection molded end caps

.090

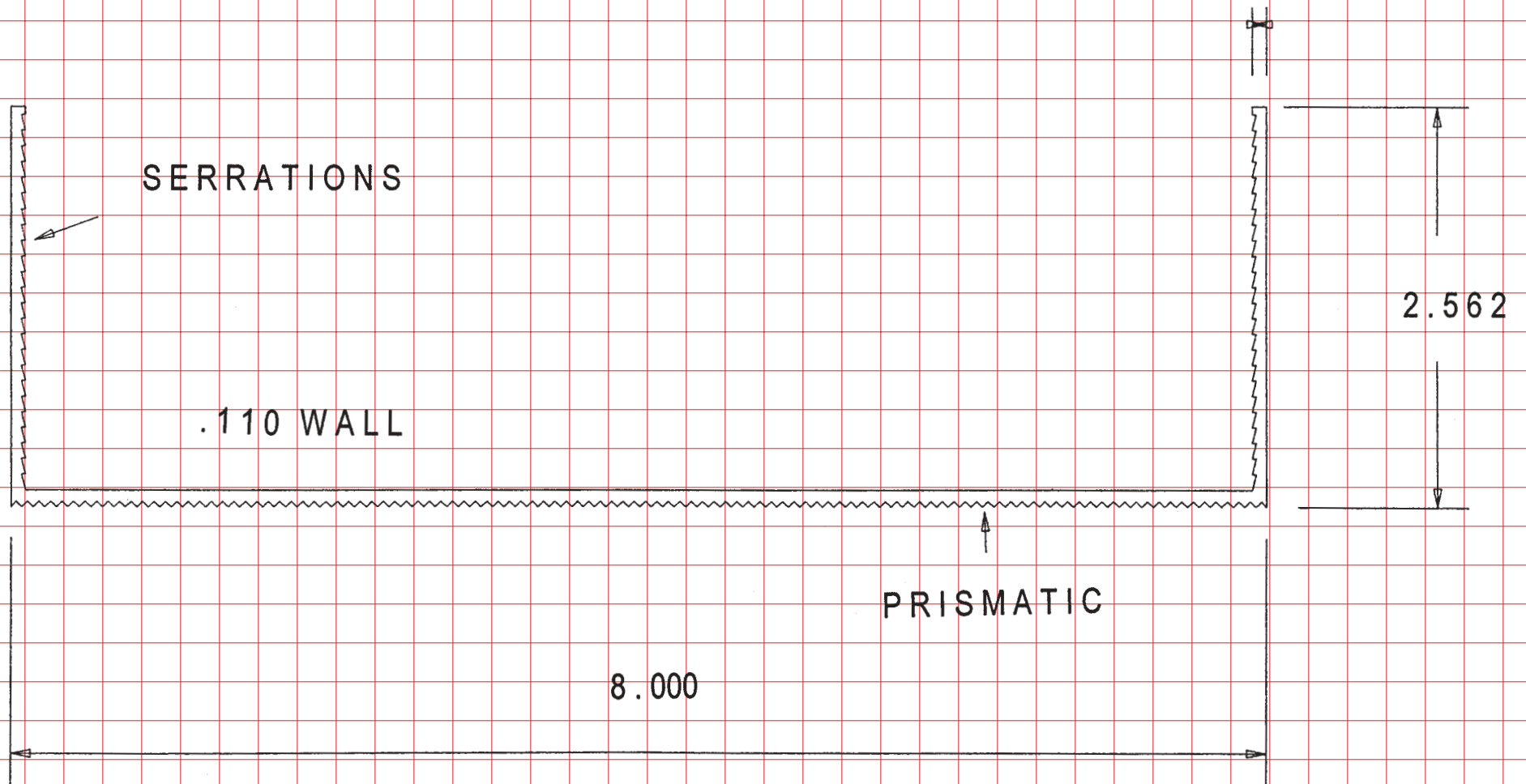

Part Number P-901-REP



REEVES
EXTRUDED
PRODUCTS, INC.
CUSTOM EXTRUSIONS

661-854-5970 • FAX 661-854-4115
(800) 868-5970

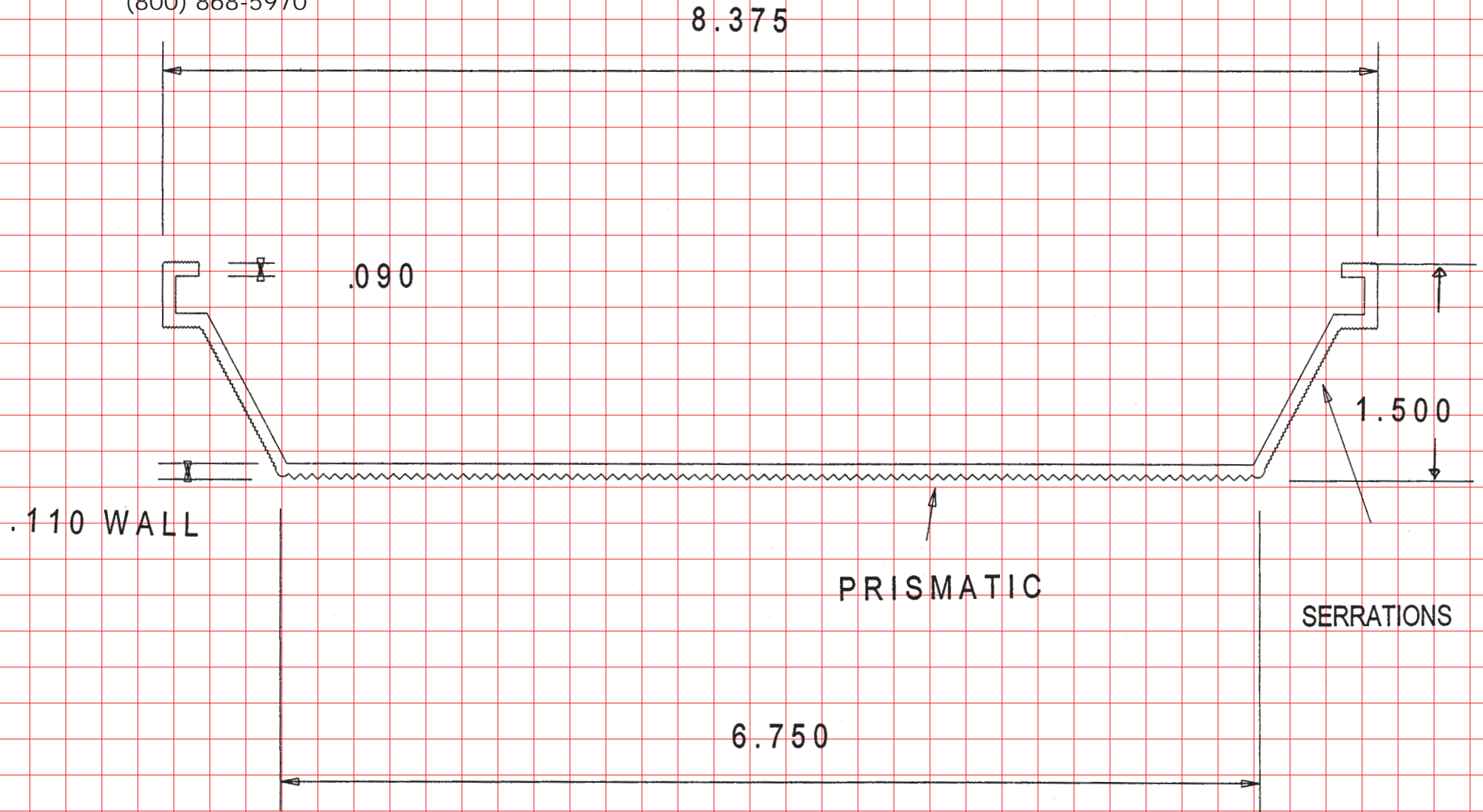

Part Number P-903-REP



REEVES
EXTRUDED
PRODUCTS, INC.
CUSTOM EXTRUSIONS

661-854-5970 • FAX 661-854-4115
(800) 868-5970

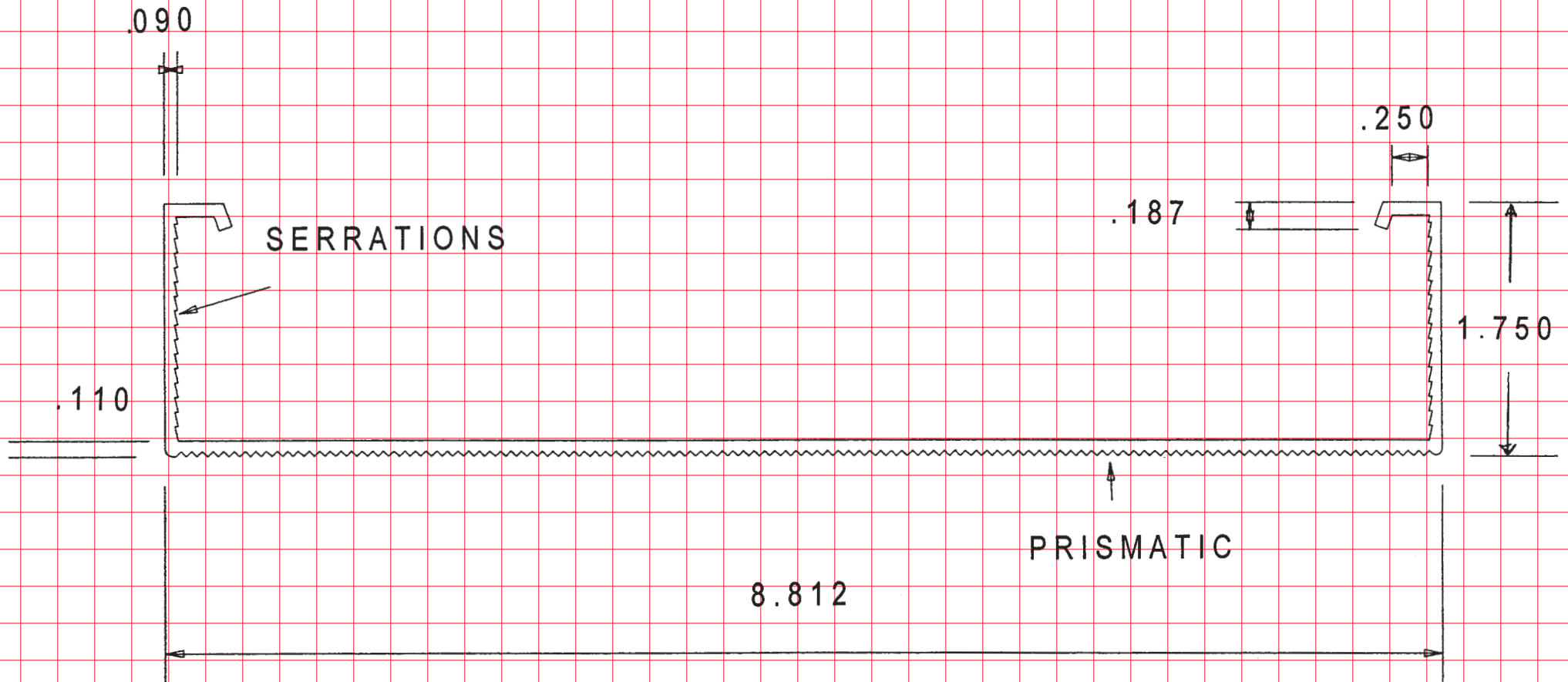

Part Number P-905-REP



REEVES
EXTRUDED
PRODUCTS, INC.
CUSTOM EXTRUSIONS

661-854-5970 • FAX 661-854-4115
(800) 868-5970

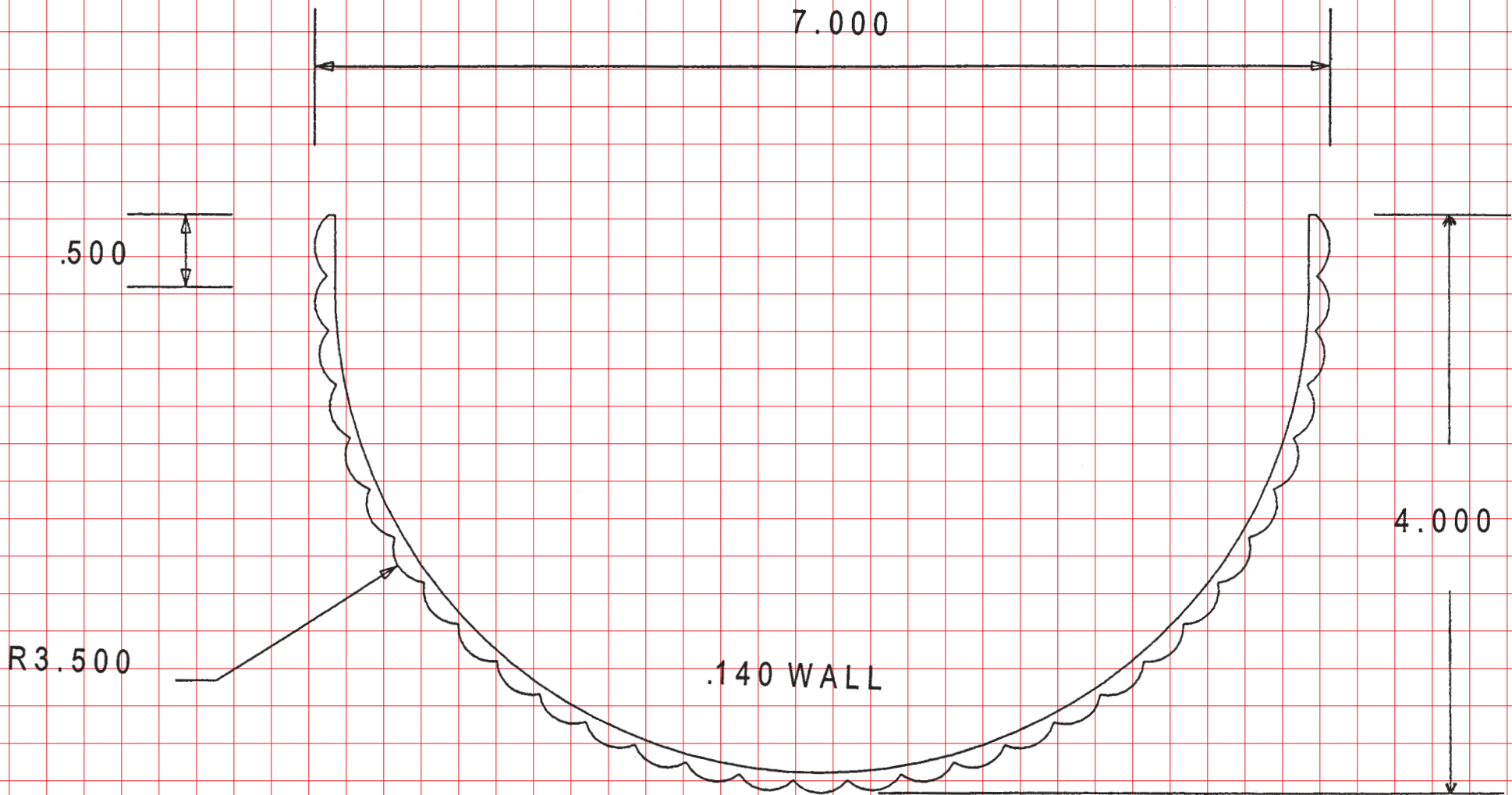

Part Number F-409-REP



REEVES
EXTRUDED
PRODUCTS, INC.
CUSTOM EXTRUSIONS

661-854-5970 • FAX 661-854-4115
(800) 868-5970

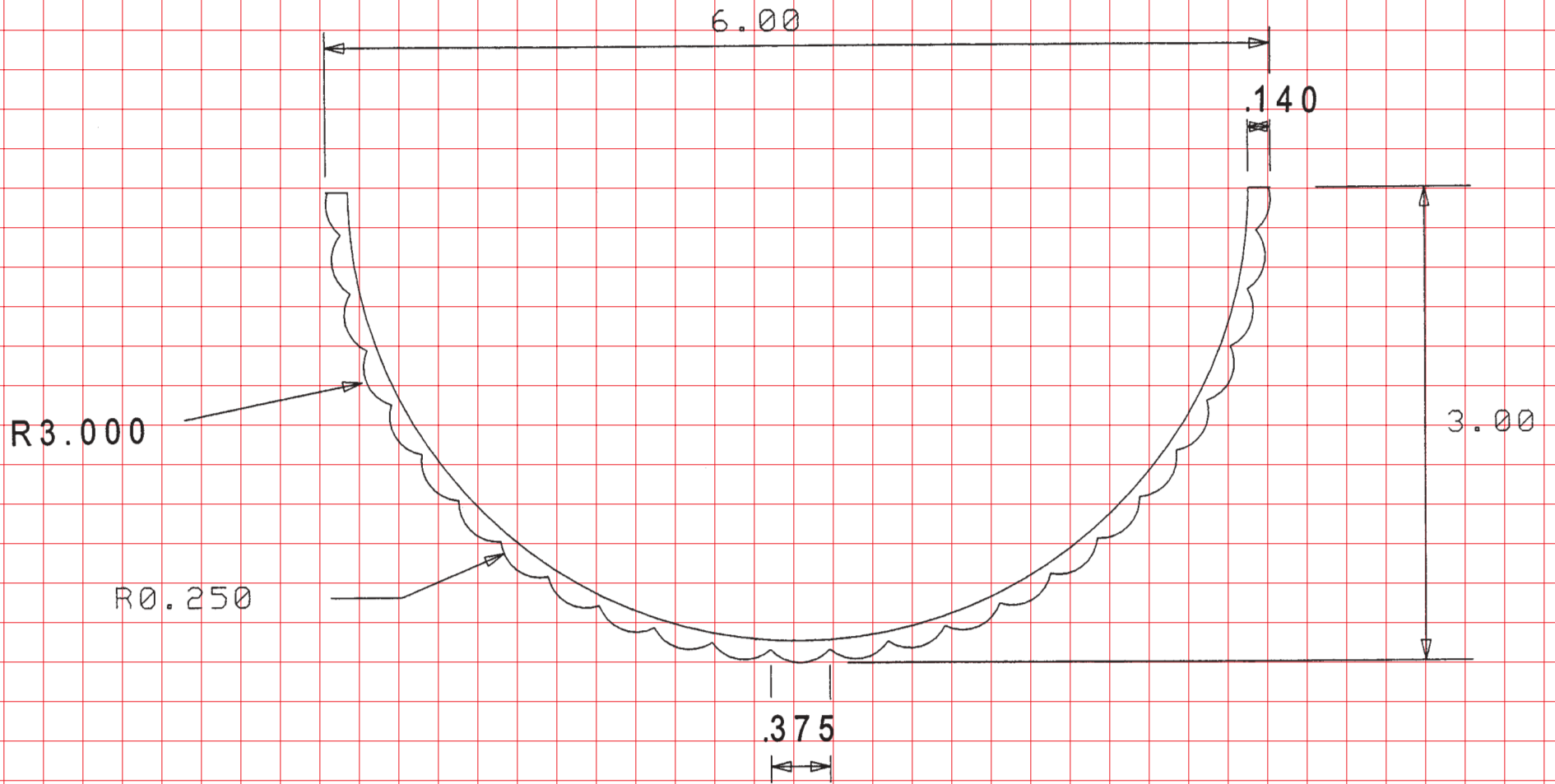

Part Number F-407-REP



REEVES
EXTRUDED
PRODUCTS, INC.
CUSTOM EXTRUSIONS

661-854-5970 • FAX 661-854-4115
(800) 868-5970

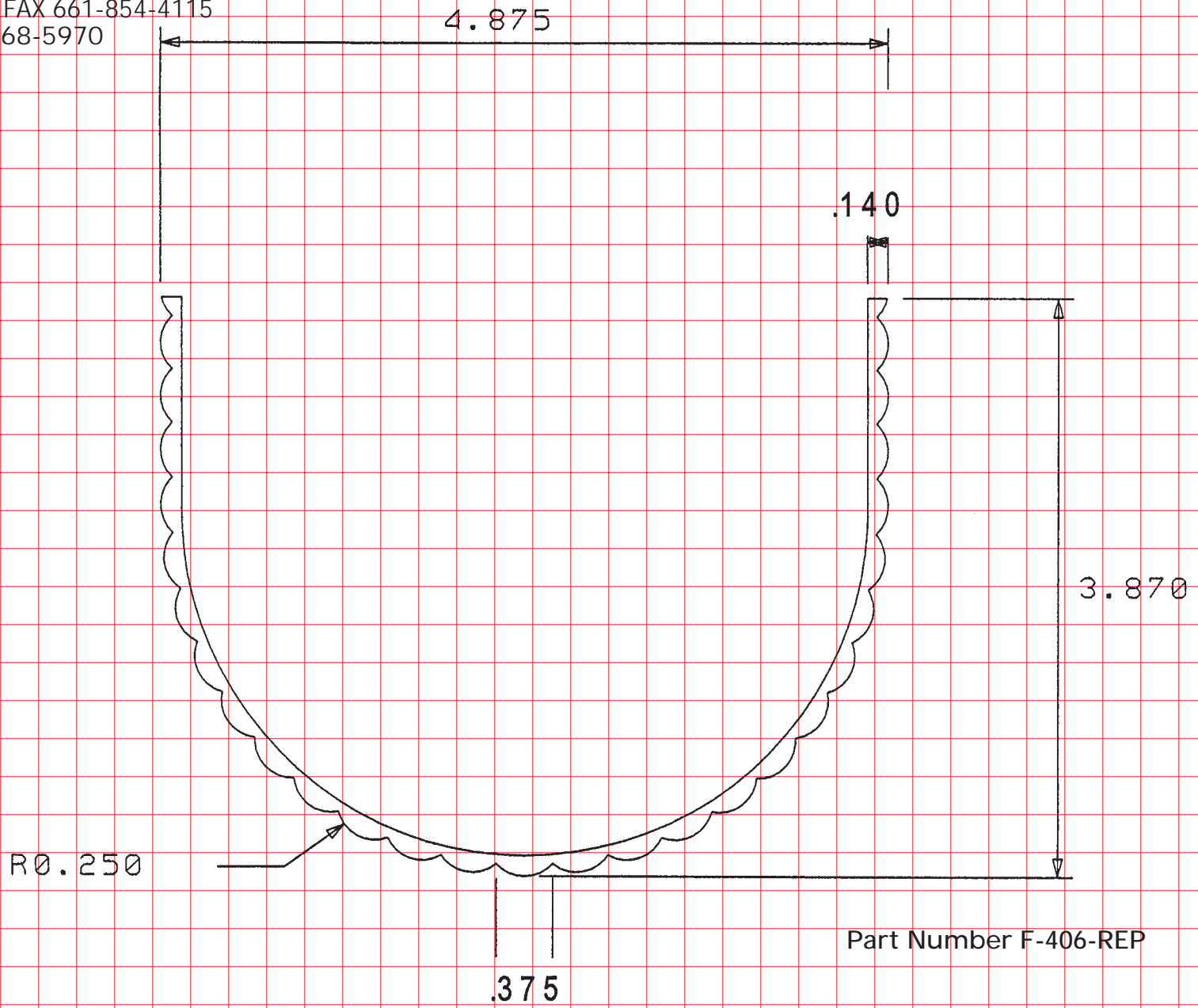



REEVES
EXTRUDED
PRODUCTS, INC.
CUSTOM EXTRUSIONS

661-854-5970 • FAX 661-854-4115
(800) 868-5970

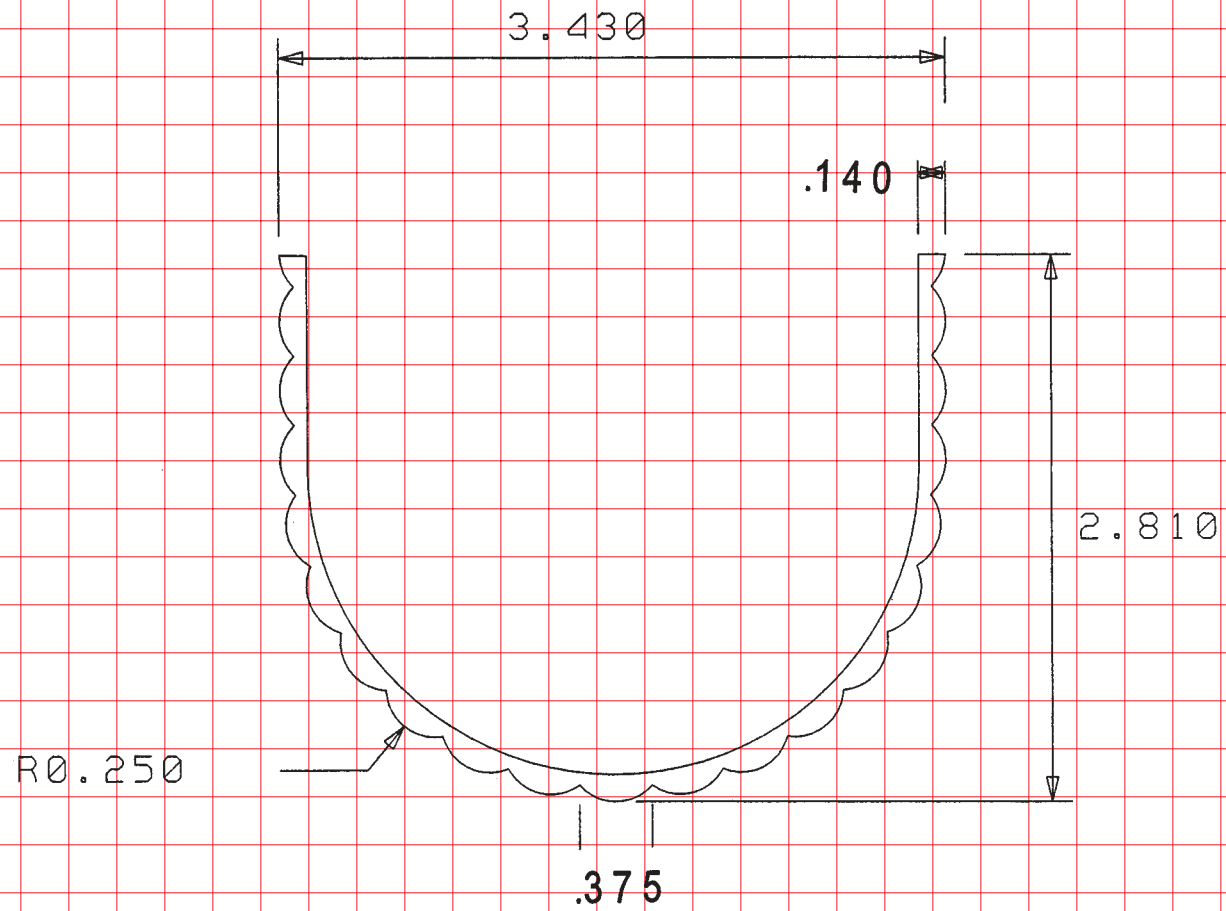

Part Number F-405-REP



REEVES
EXTRUDED
PRODUCTS, INC.
CUSTOM EXTRUSIONS

661-854-5970 • FAX 661-854-4115
(800) 868-5970

1/4 CIRCLE

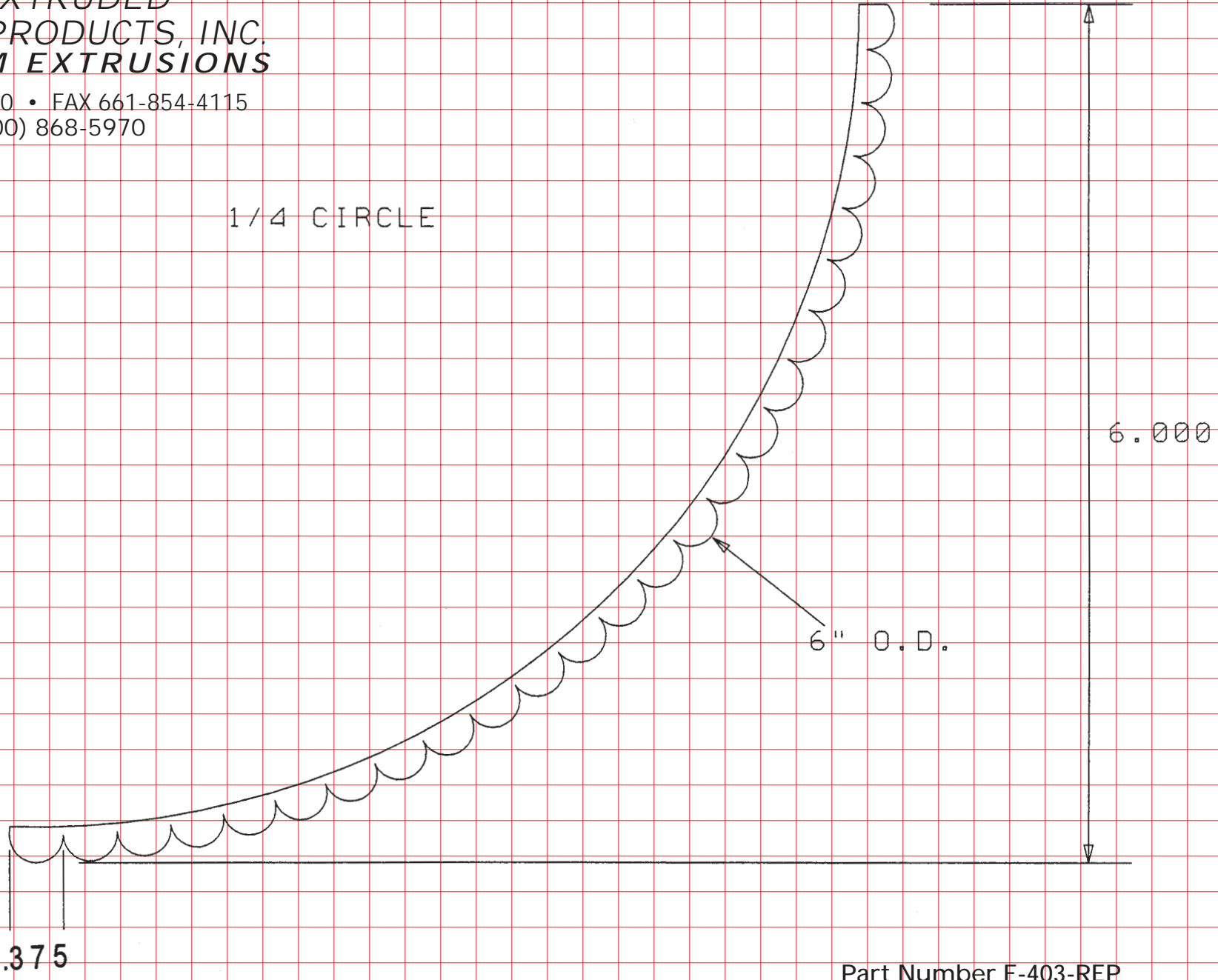

Part Number F-403-REP



REEVES
EXTRUDED
PRODUCTS, INC.
CUSTOM EXTRUSIONS

661-854-5970 • FAX 661-854-4115
(800) 868-5970

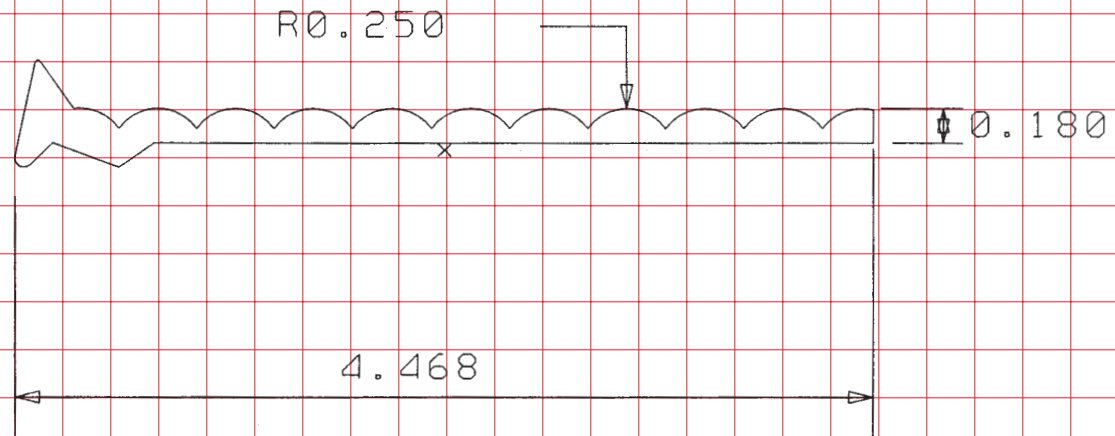

Part Number F-401-REP



REEVES
EXTRUDED
PRODUCTS, INC.
CUSTOM EXTRUSIONS

661-854-5970 • FAX 661-854-4115
(800) 868-5970

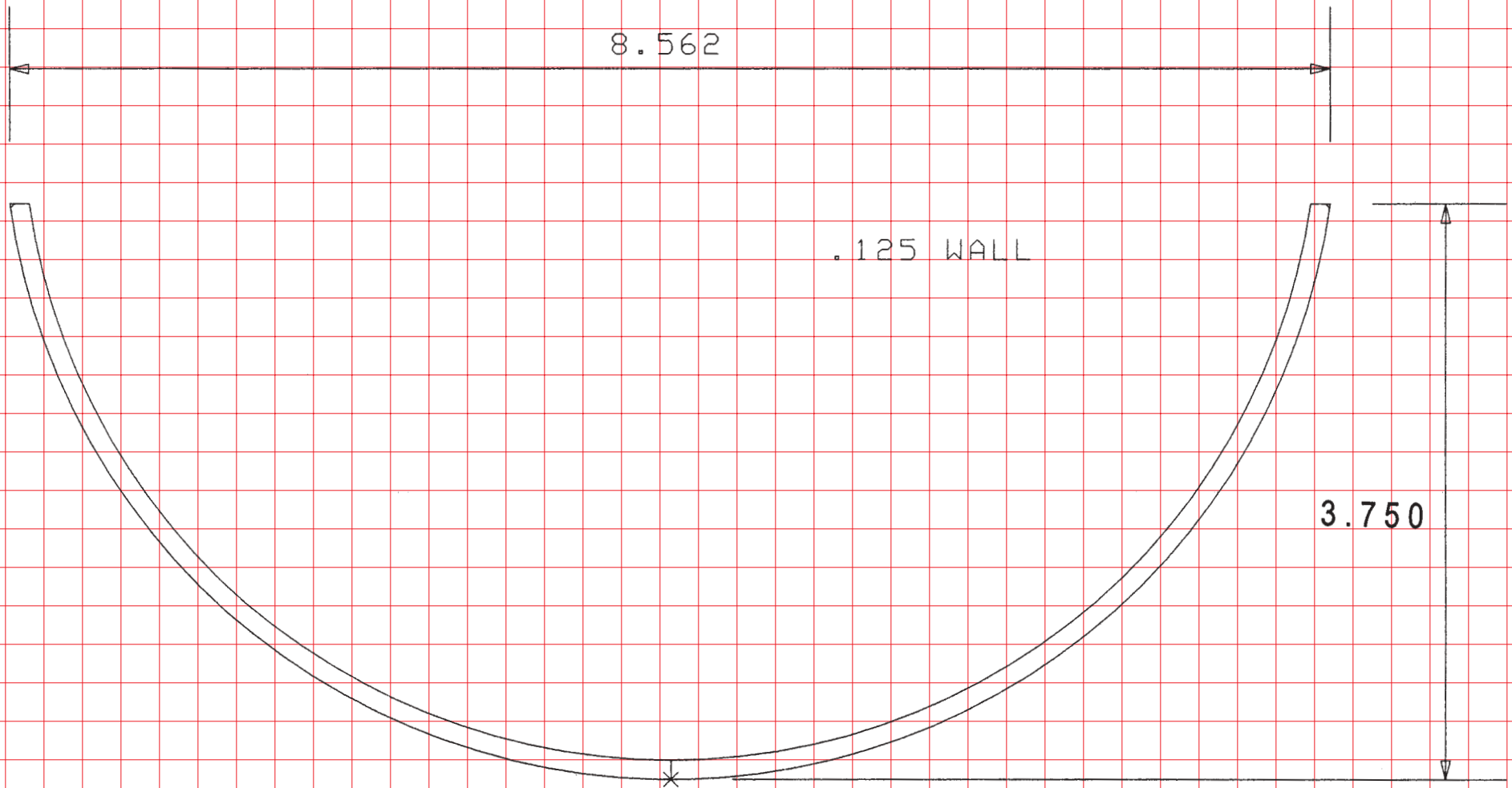

Part Number C-309-REP



REEVES
EXTRUDED
PRODUCTS, INC.
CUSTOM EXTRUSIONS

661-854-5970 • FAX 661-854-4115
(800) 868-5970

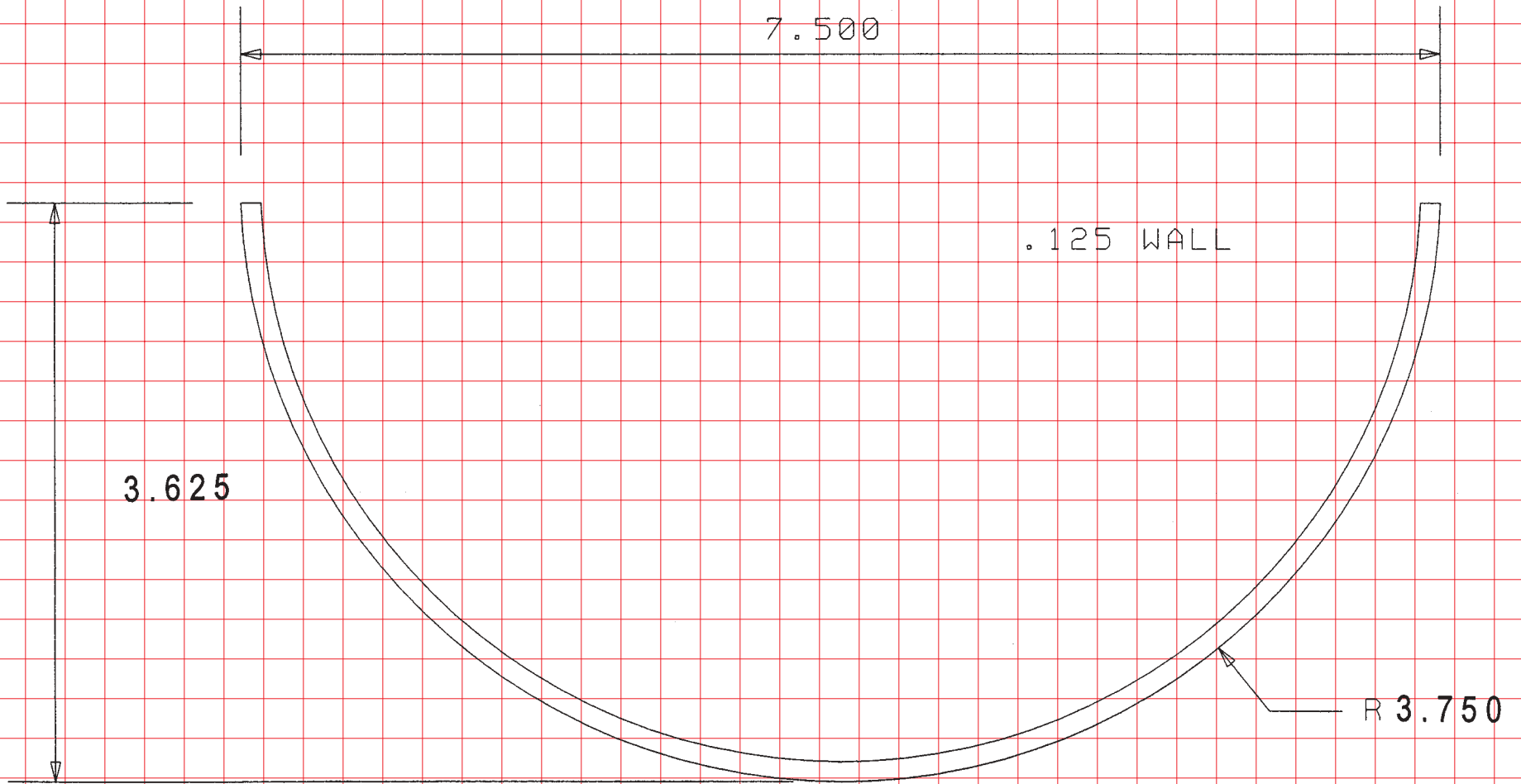

Part Number C-308-REP



REEVES
EXTRUDED
PRODUCTS, INC.
CUSTOM EXTRUSIONS

661-854-5970 • FAX 661-854-4115
(800) 868-5970

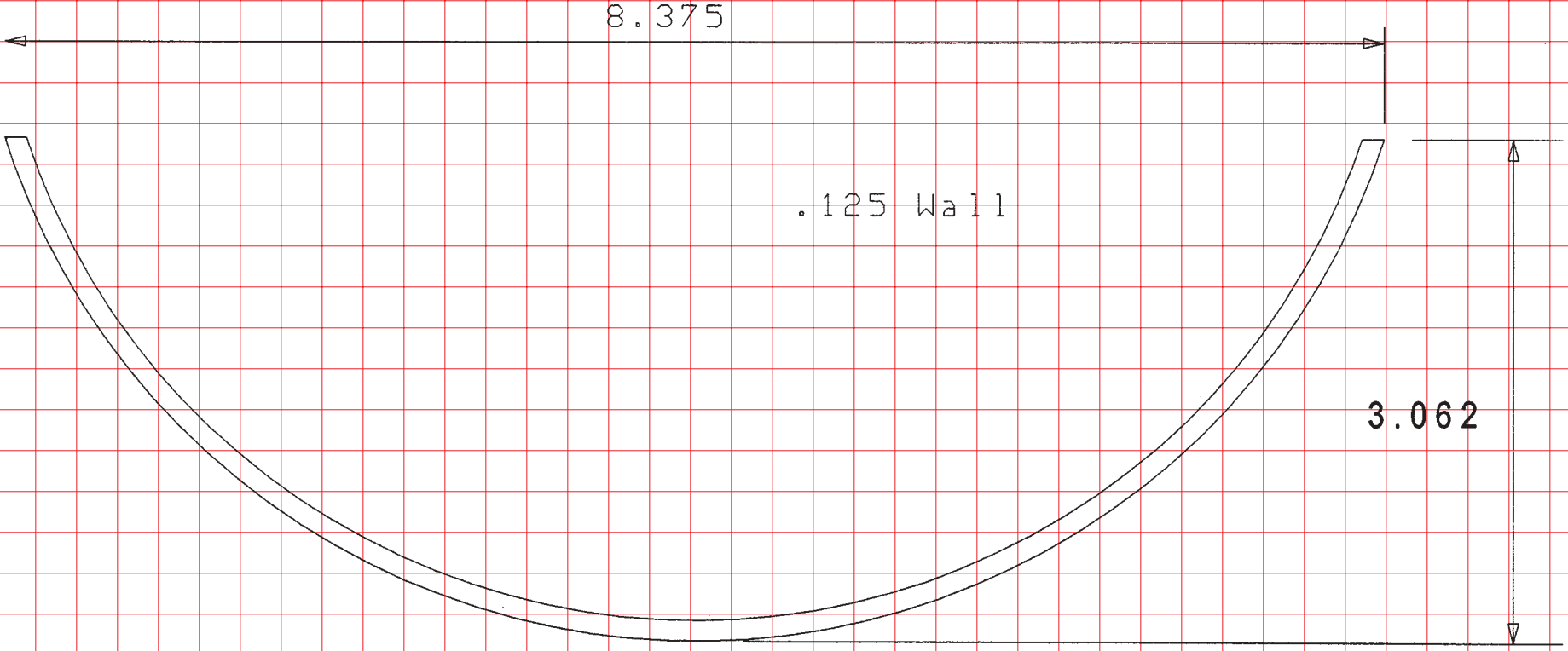

Part Number C-307-REP



REEVES
EXTRUDED
PRODUCTS, INC.
CUSTOM EXTRUSIONS

661-854-5970 • FAX 661-854-4115
(800) 868-5970

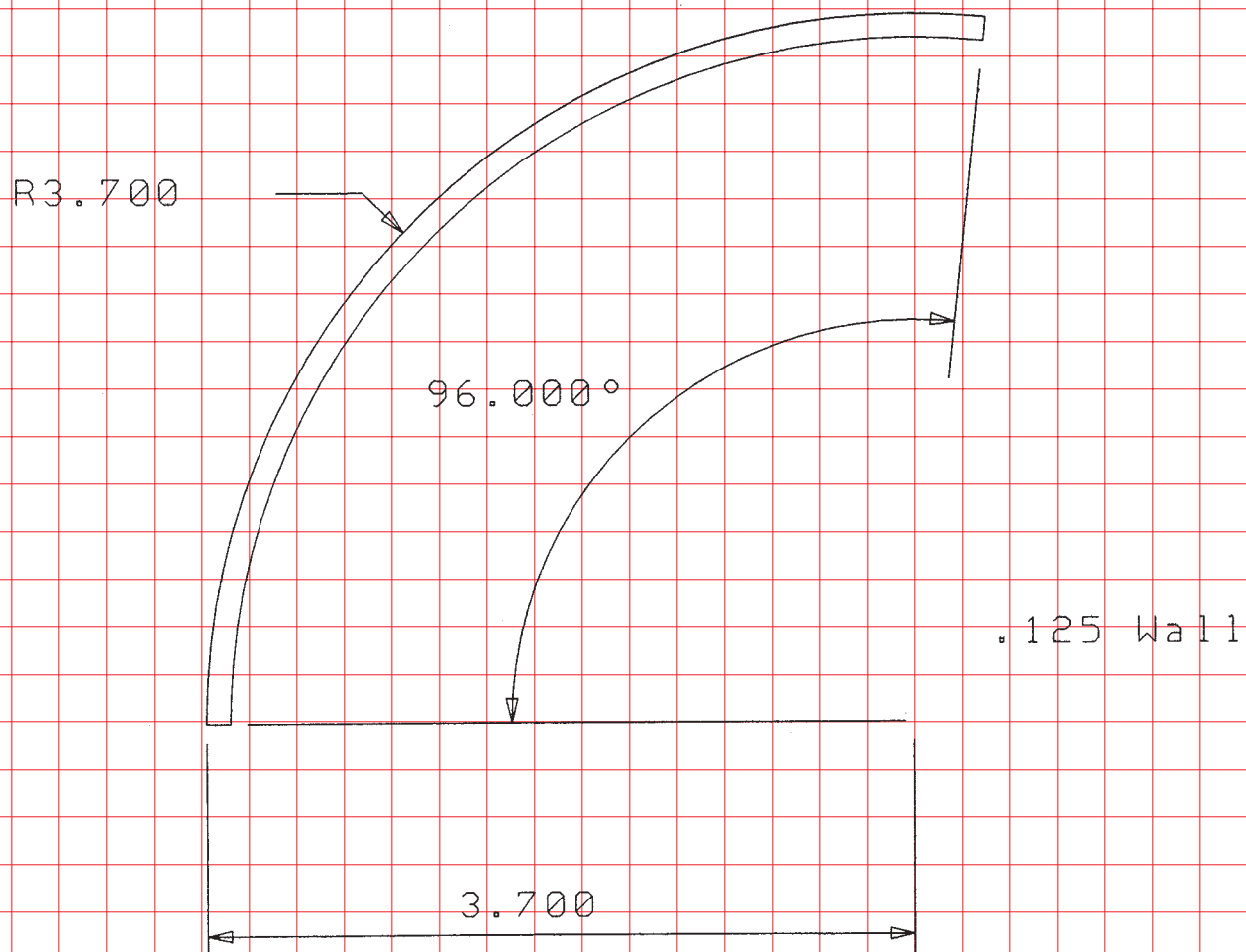

Part Number C-306-REP



REEVES
EXTRUDED
PRODUCTS, INC.
CUSTOM EXTRUSIONS

661-854-5970 • FAX 661-854-4115
(800) 868-5970

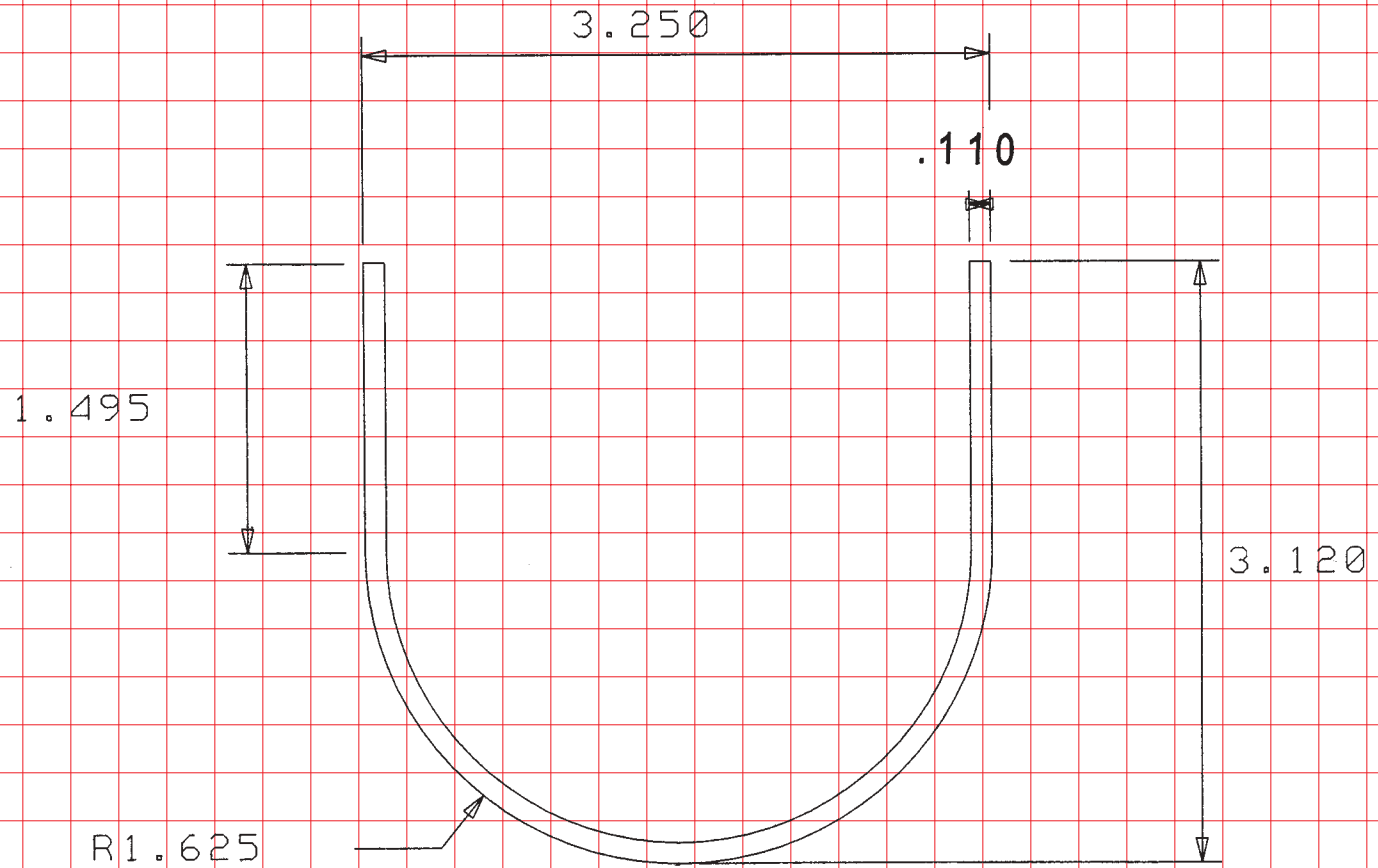

Part Number C-305-REP



REEVES
EXTRUDED
PRODUCTS, INC.
CUSTOM EXTRUSIONS

661-854-5970 • FAX 661-854-4115
(800) 868-5970

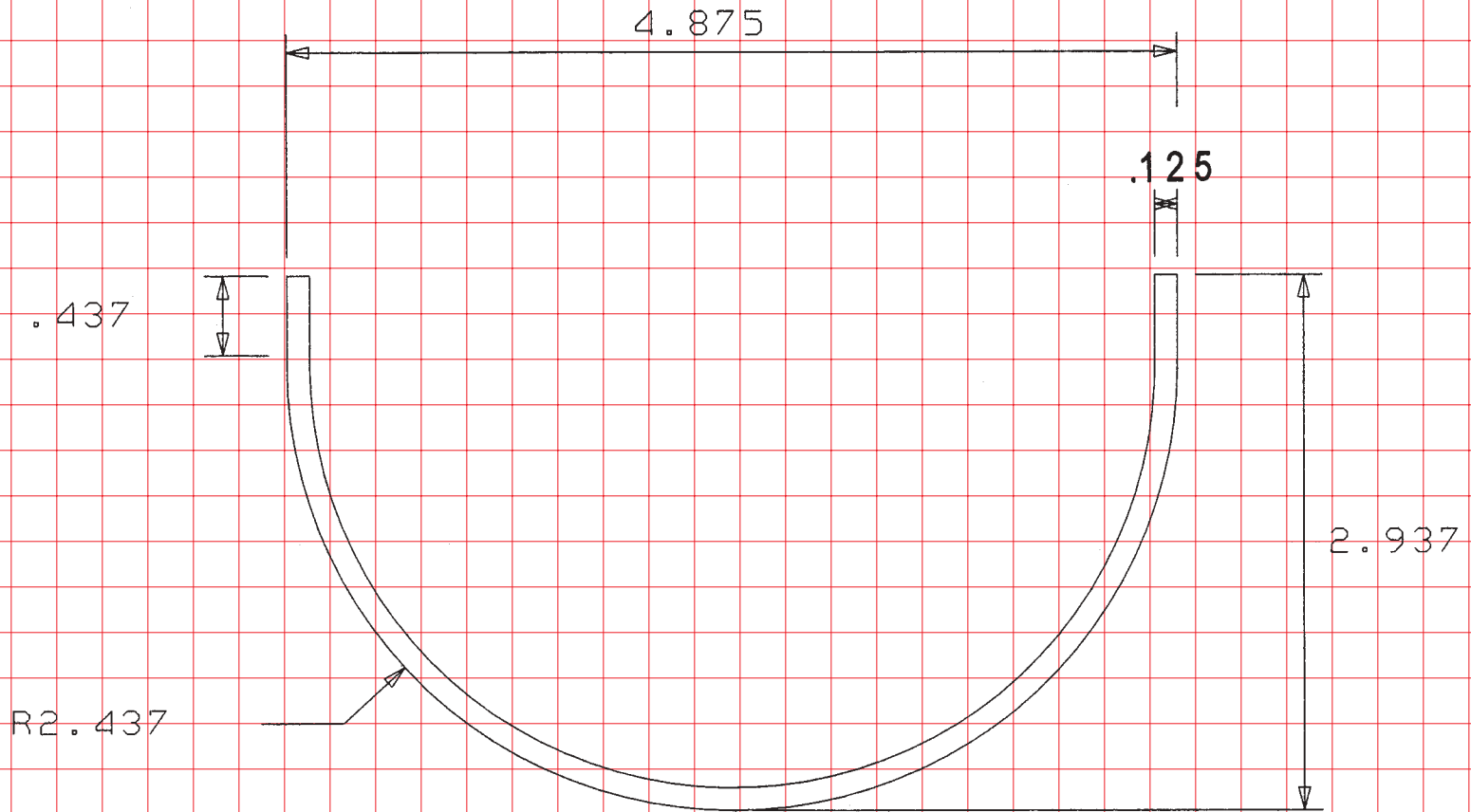

Part Number C-304-REP



REEVES
EXTRUDED
PRODUCTS, INC.
CUSTOM EXTRUSIONS

661-854-5970 • FAX 661-854-4115
(800) 868-5970

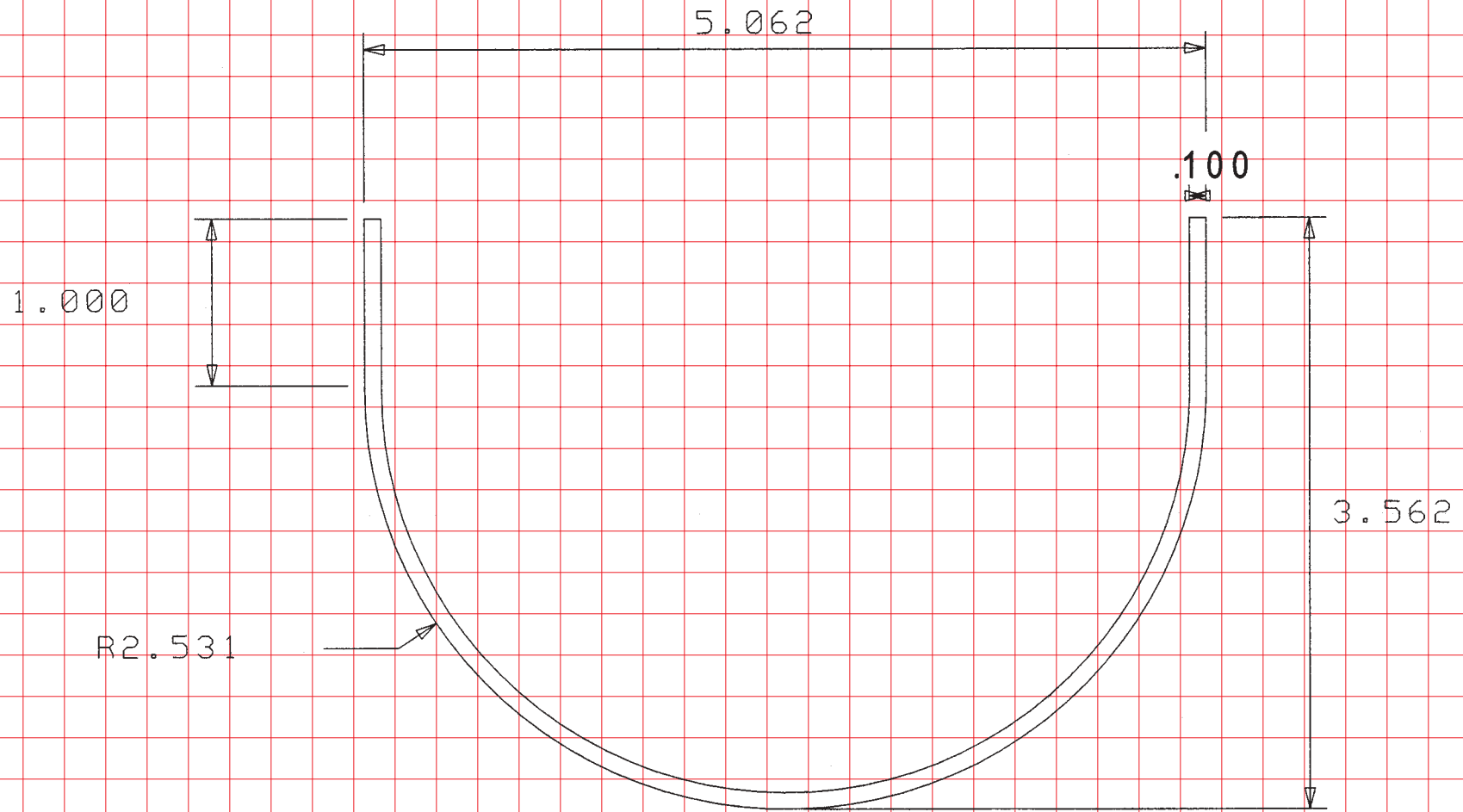

Part Number C-303-REP



REEVES
EXTRUDED
PRODUCTS, INC.
CUSTOM EXTRUSIONS

661-854-5970 • FAX 661-854-4115
(800) 868-5970

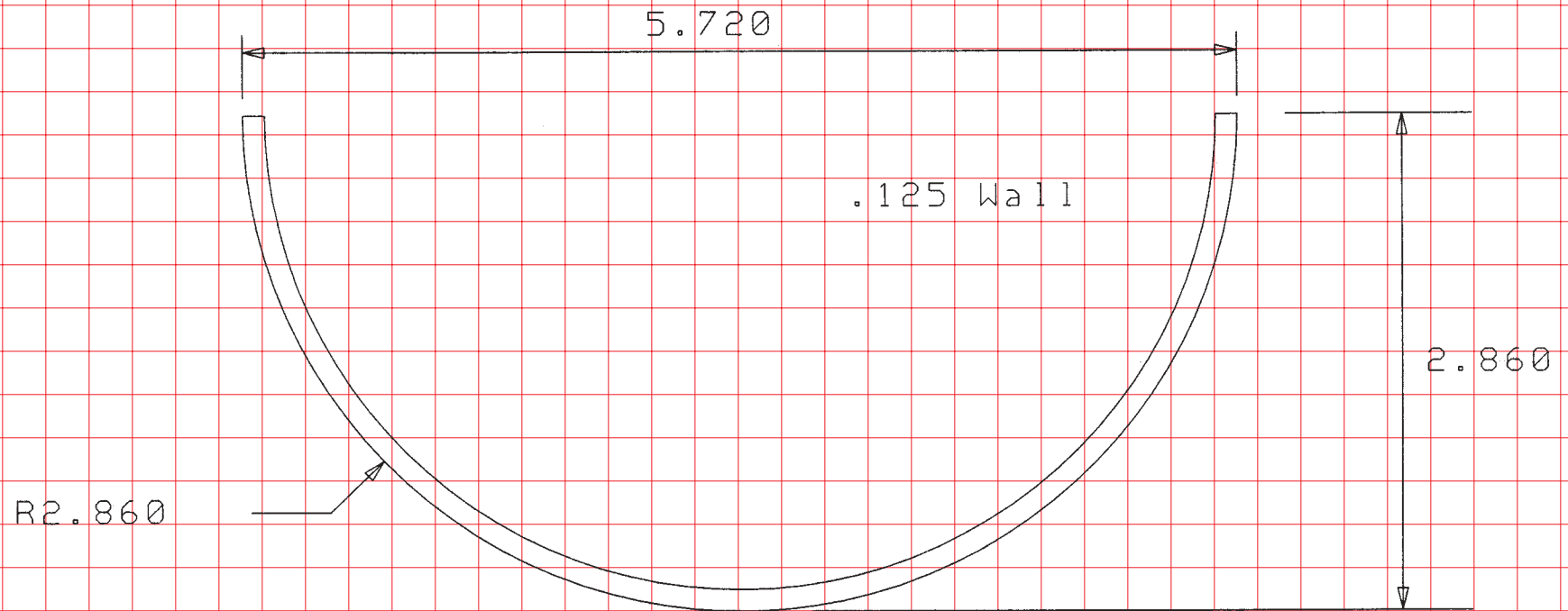

Part Number C-302-REP



REEVES
EXTRUDED
PRODUCTS, INC.
CUSTOM EXTRUSIONS

661-854-5970 • FAX 661-854-4115
(800) 868-5970

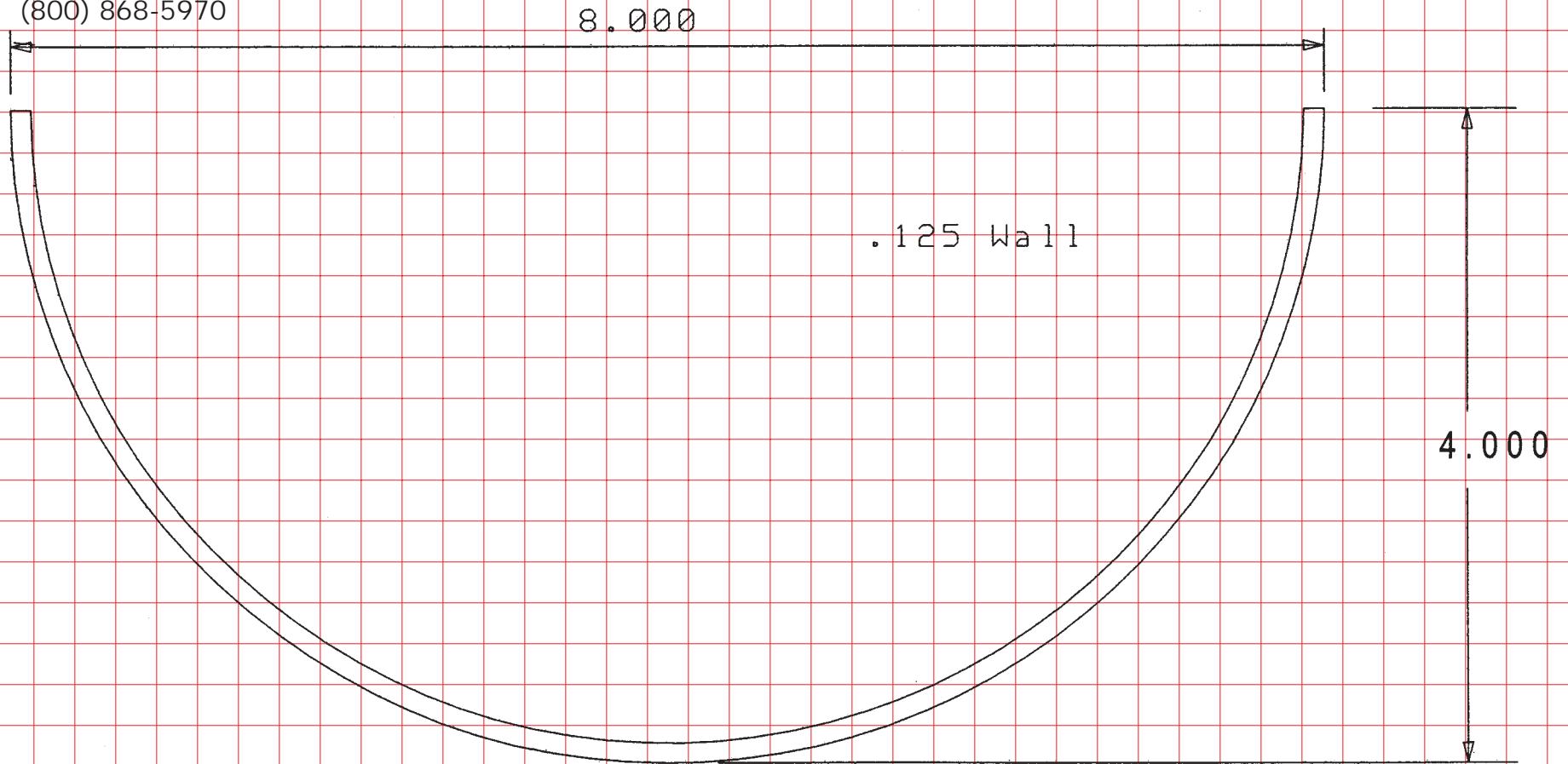

Part Number C-301-REP



REEVES
EXTRUDED
PRODUCTS, INC.
CUSTOM EXTRUSIONS

661-854-5970 • FAX 661-854-4115
(800) 868-5970

.070 WALL

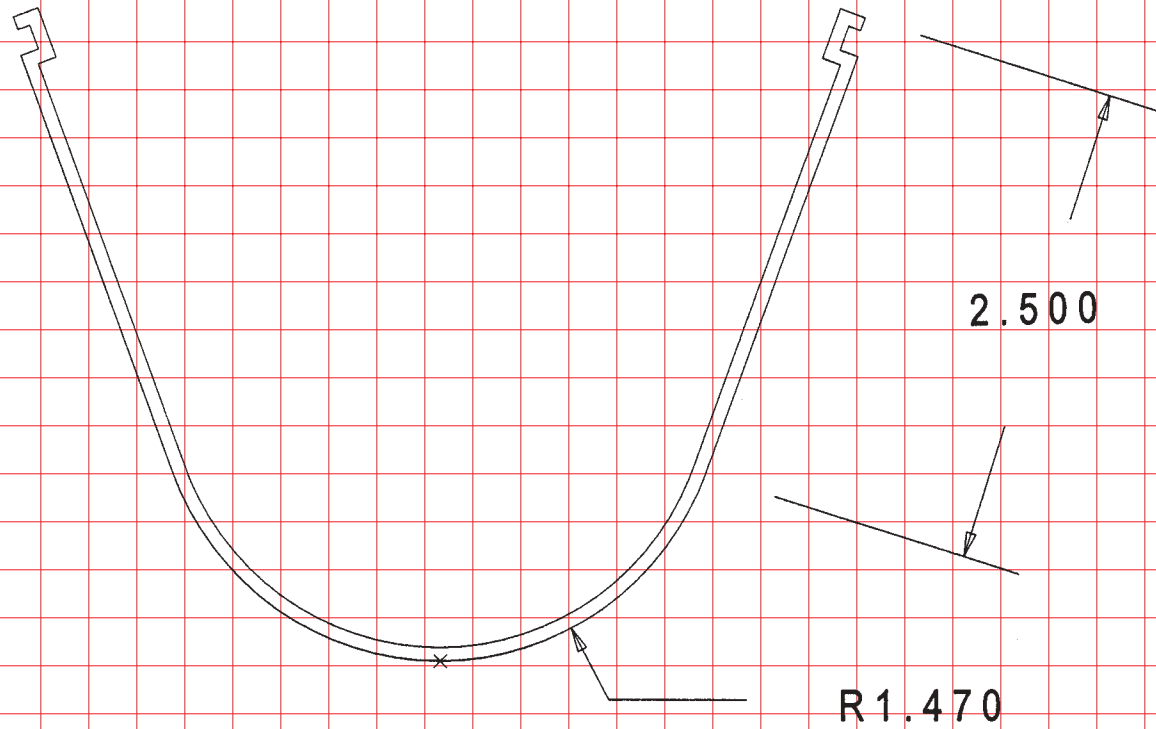

Part Number H-807-REP



REEVES
EXTRUDED
PRODUCTS, INC.
CUSTOM EXTRUSIONS

661-854-5970 • FAX 661-854-4115
(800) 868-5970

.090 WALL

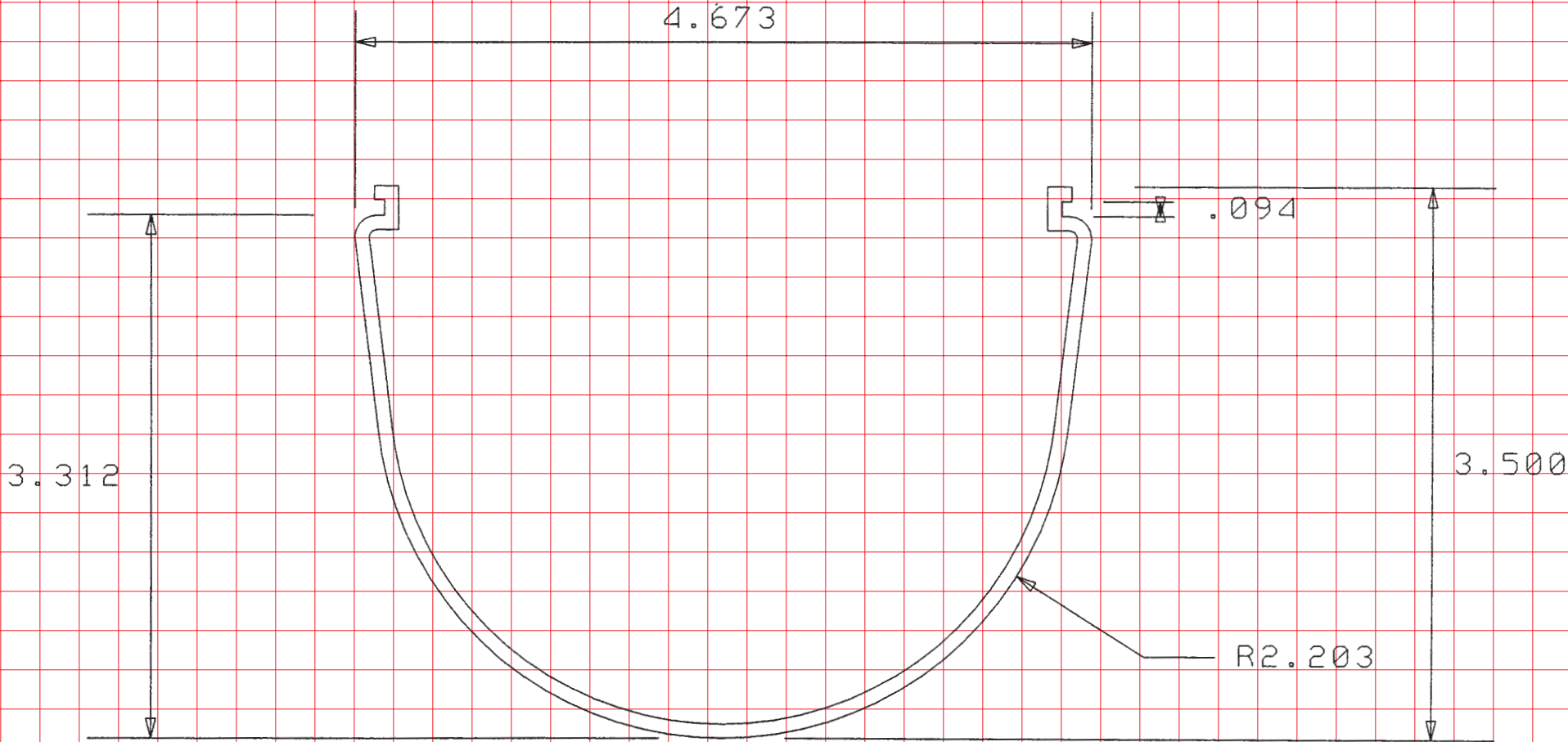

Part Number H-805-REP



REEVES
EXTRUDED
PRODUCTS, INC.
CUSTOM EXTRUSIONS

661-854-5970 • FAX 661-854-4115
(800) 868-5970

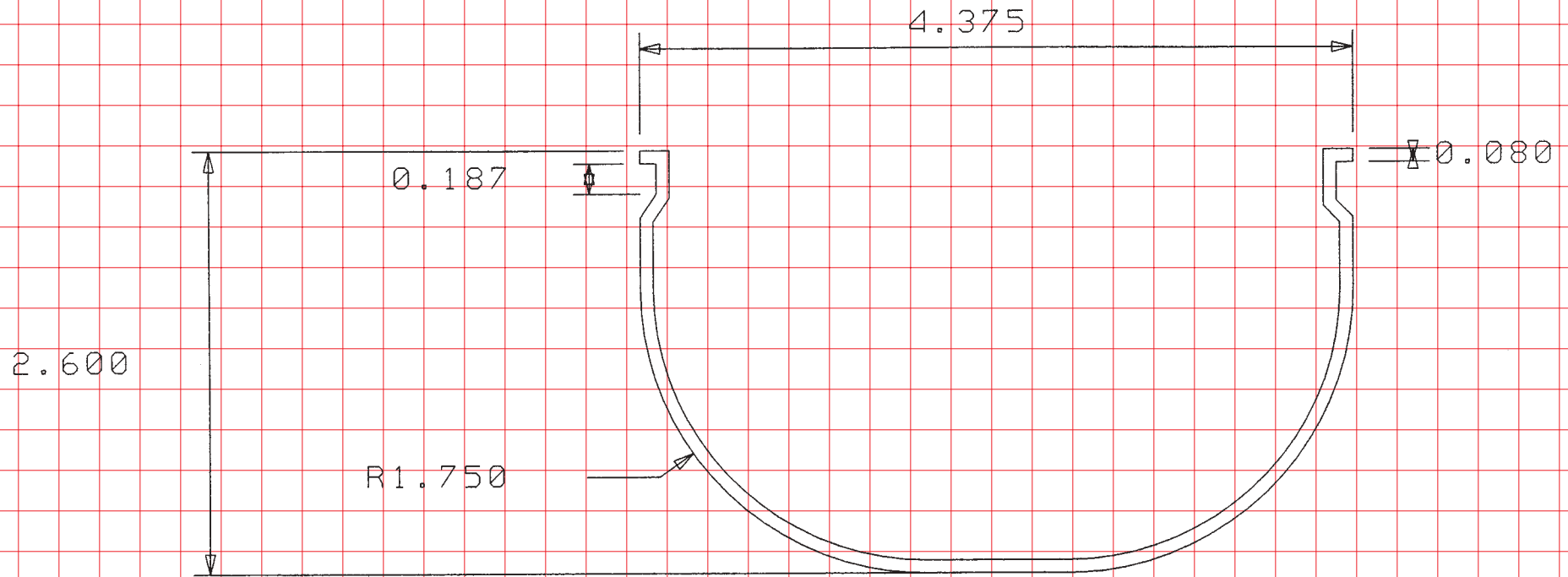

Part Number H-803-REP



REEVES
EXTRUDED
PRODUCTS, INC.
CUSTOM EXTRUSIONS

661-854-5970 • FAX 661-854-4115
(800) 868-5970

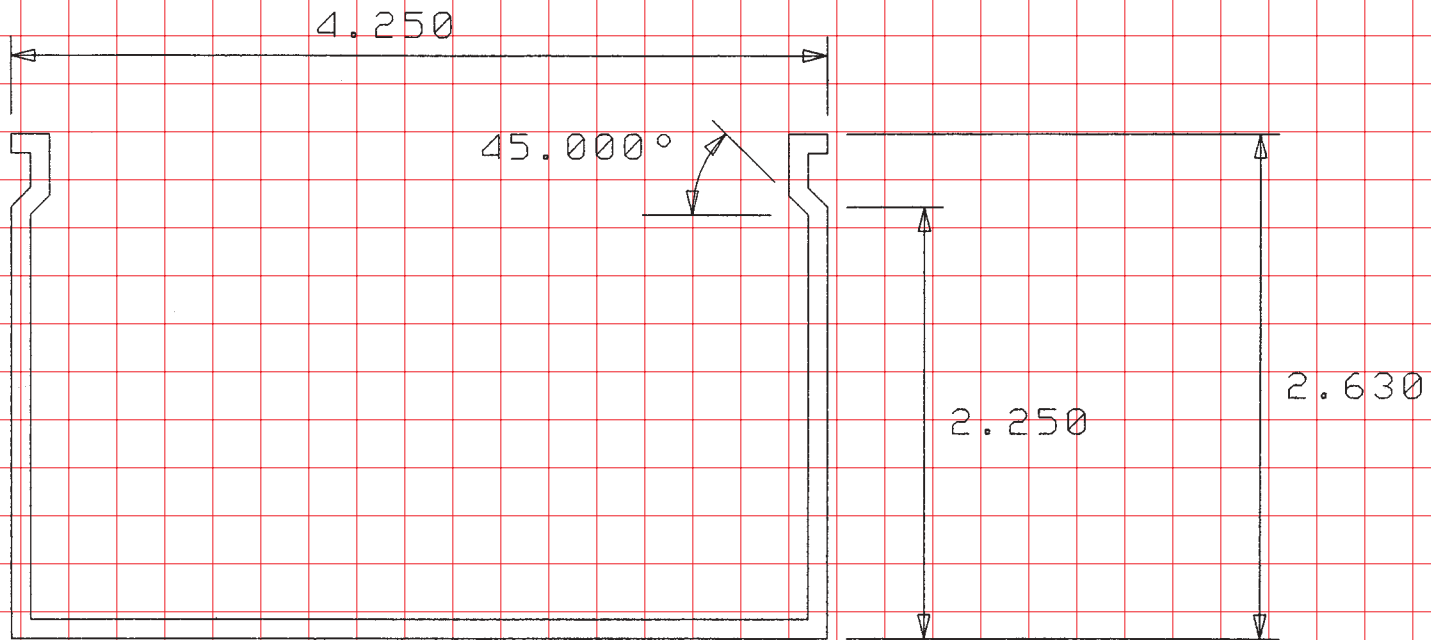

Part Number H-801-REP



REEVES
EXTRUDED
PRODUCTS, INC.
CUSTOM EXTRUSIONS

661-854-5970 • FAX 661-854-4115
(800) 868-5970

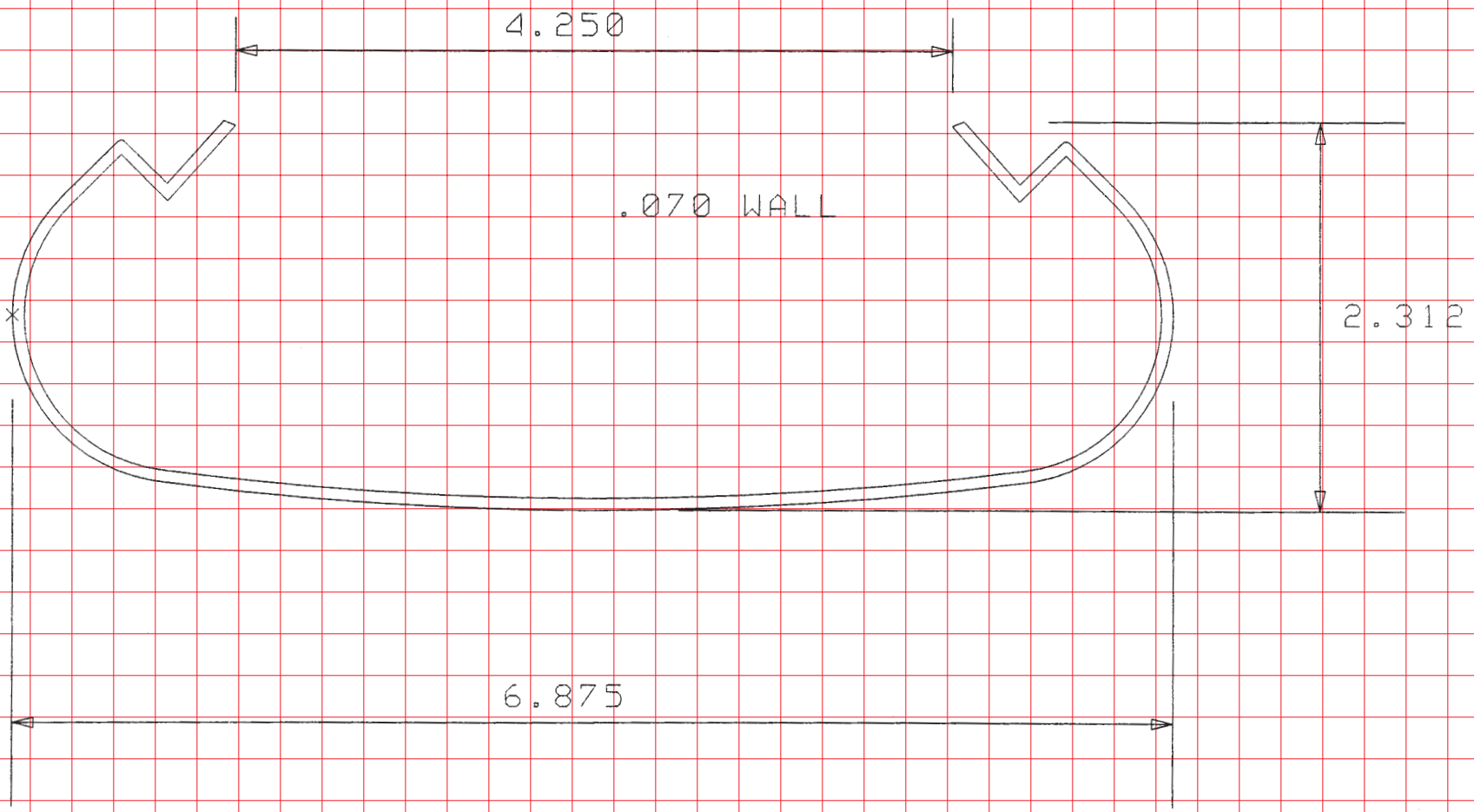

Part Number S-505-REP



REEVES
EXTRUDED
PRODUCTS, INC.
CUSTOM EXTRUSIONS

661-854-5970 • FAX 661-854-4115
(800) 868-5970

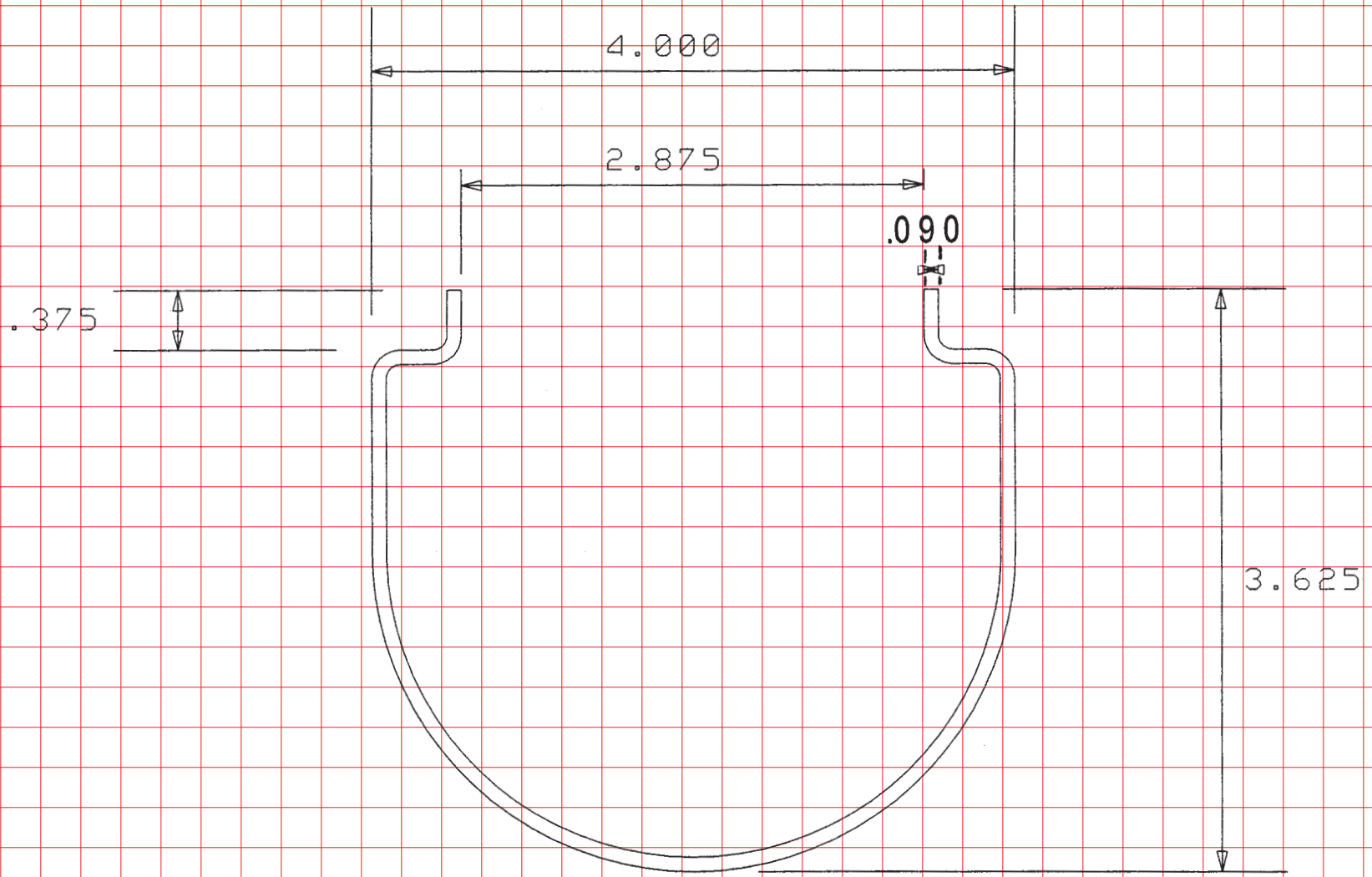

Part Number S-503-REP